

Thank you for buying our product

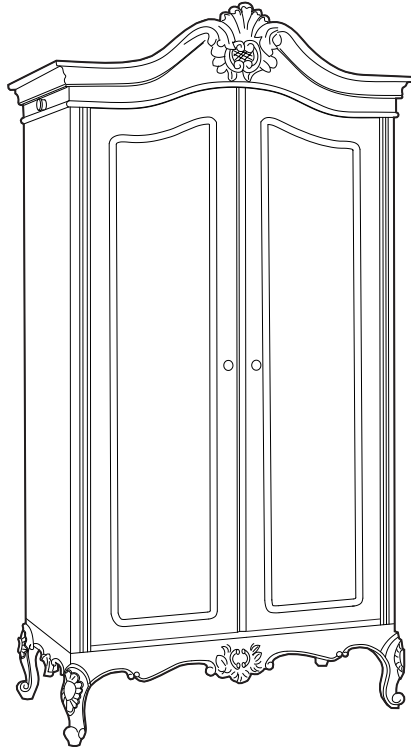

Step By Step Assembly Instructions

PRE-ASSEMBLY PREPARATION

1. Please check the pack contents before attempting this product.
A full checklist of components is given in this leaflet. If any component are missing, please contact the retailer from whom you bought this product.
2. This product is **heavy**, it should be assembled as near as possible to the point of use.
TAKE CARE WITH LIFTING to avoid personal injury and (or) damage to the product.
3. This product takes approximately 10 minutes to assemble with 2 people.
4. The fitting pack contains **small items** which should be :
KEPT AWAY FROM YOUNG CHILDREN.
5. Read this leaflet in full before commencing assembly.
6. You will require a crosshead screwdriver and Allen key (provided) to assemble this product.
7. **WE RECOMMEND** that you lay a protective cloth on your carpet during assembly, **to prevent marking.**

Gavotte 2 Door Wardrobe KD (GV06) Assembly Instruction

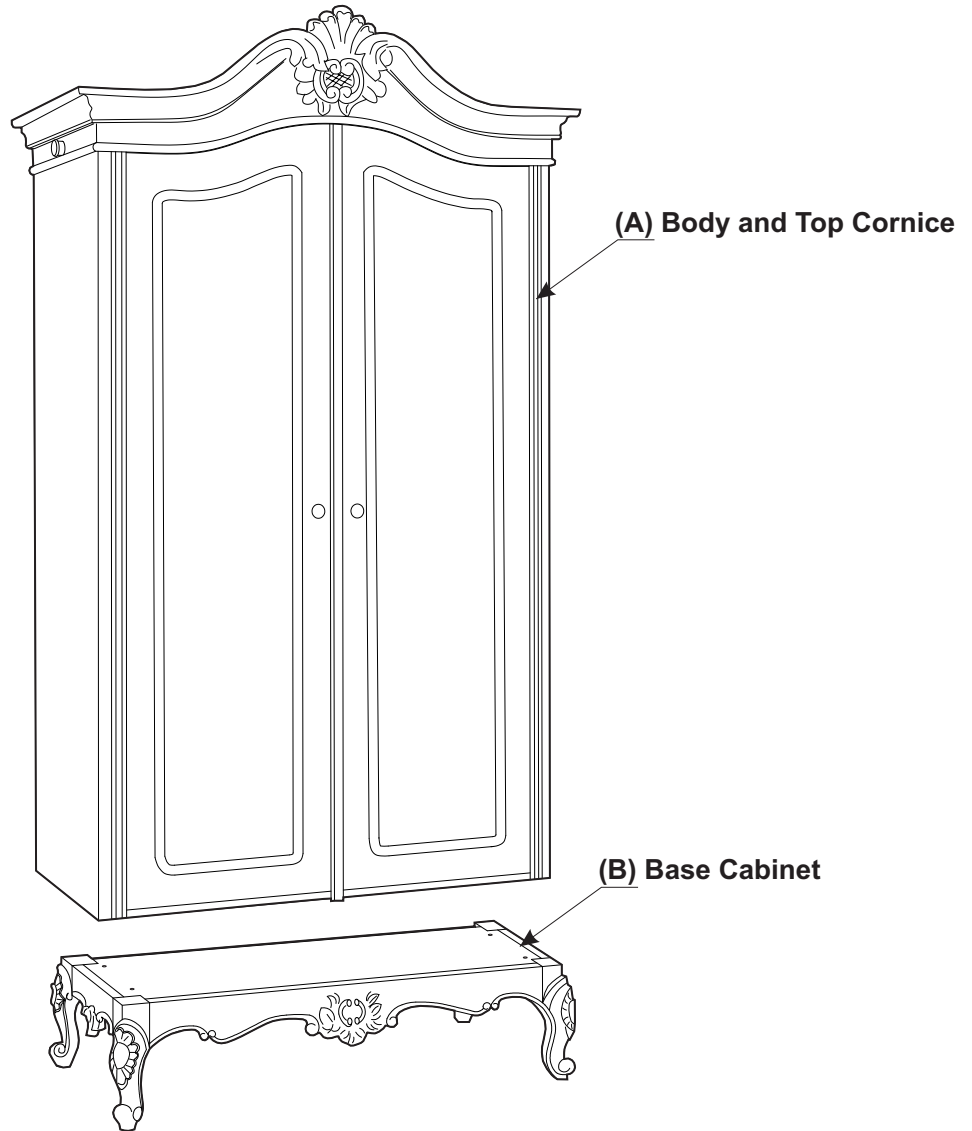

Panel and Fitting Identification

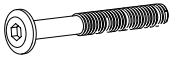
Item	Description	Qty
A	Body and Top Cornice	1
B	Base Leg Cabinet	1
C	Allen Bolt 	4
D	Hanging Rail	1
E	Allen Key	1

Gavotte 2 Door Wardrobe KD (GV06) Assembly Instruction

Step 1. (Body and Top cornice) & Base Leg Cabinet Assembly

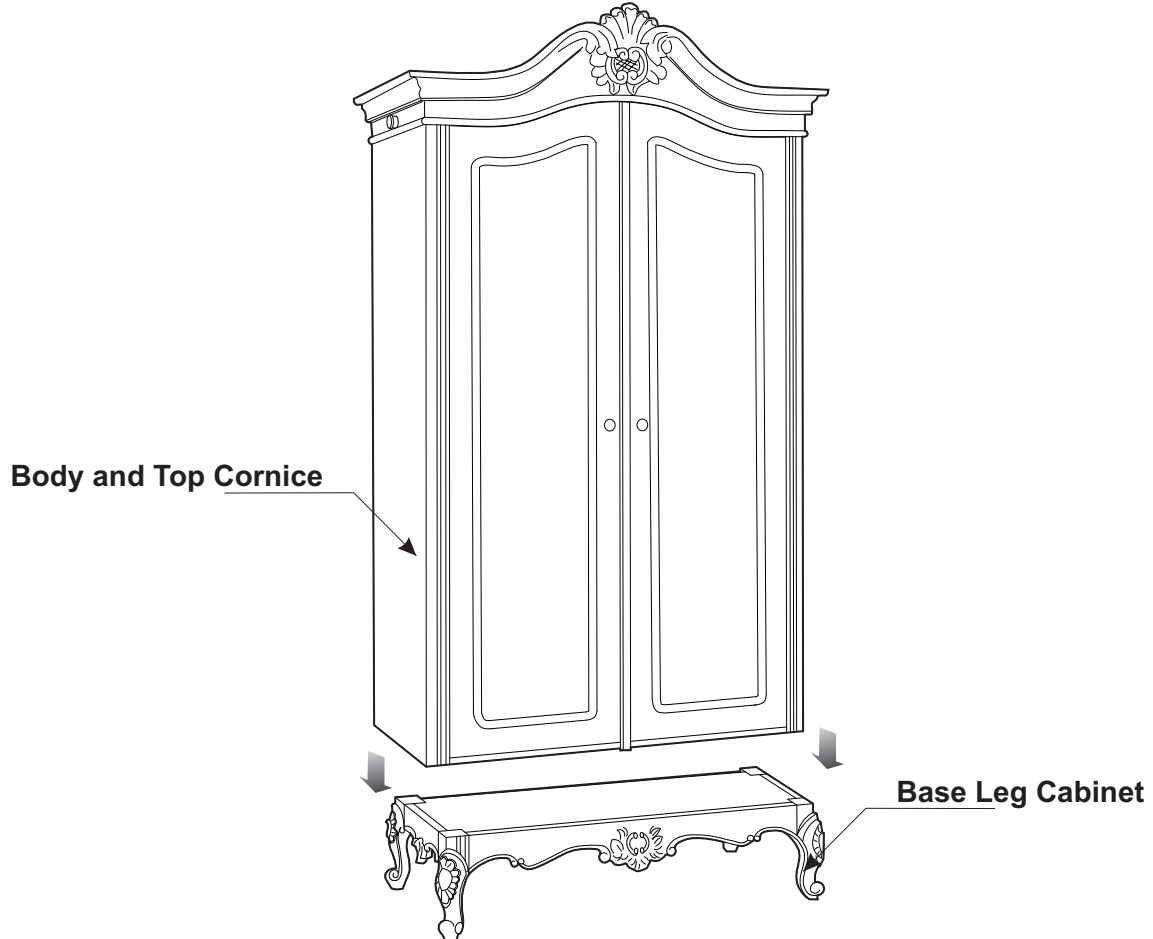

Move down Body and top cornice until match hole on base leg cabinet and insert allen bolt in hole (turn clockwise)

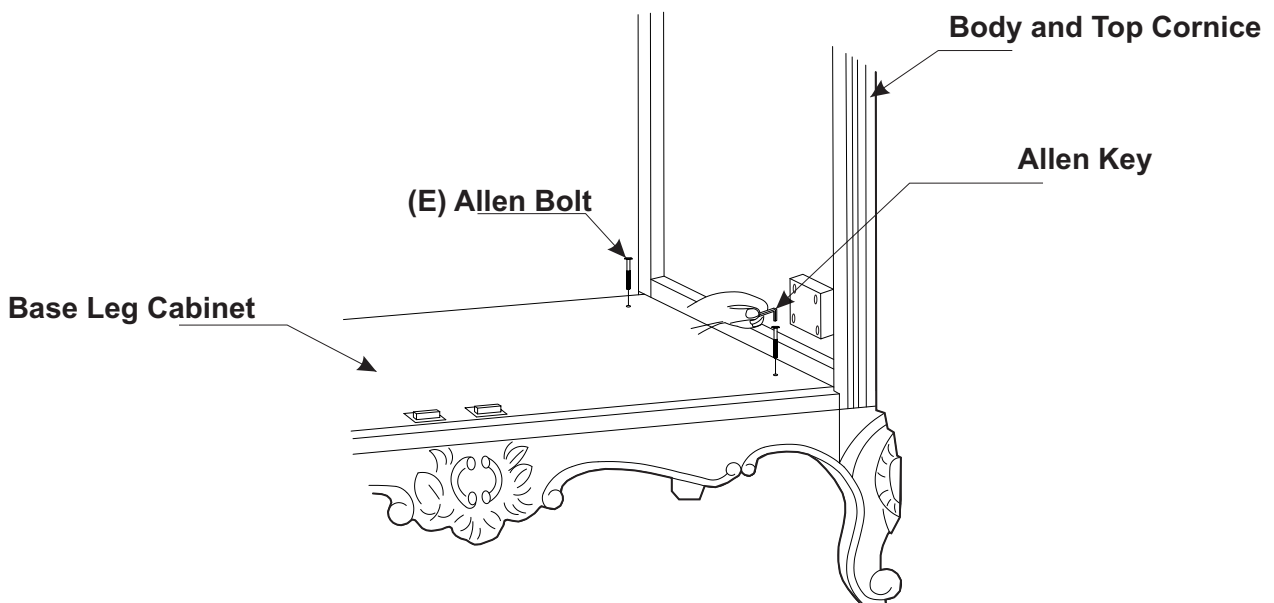

Gavotte 2 Door Wardrobe KD (GV06) Assembly Instruction

Step 2. Adjustable Door

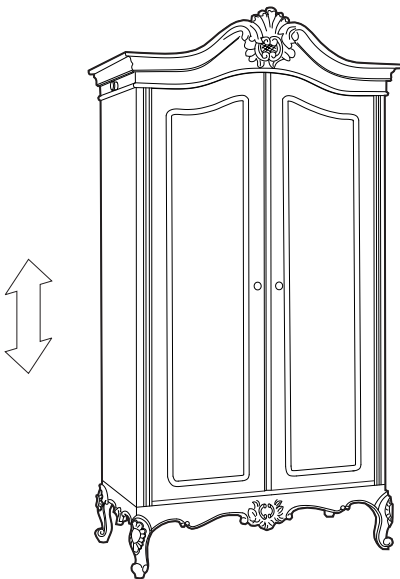
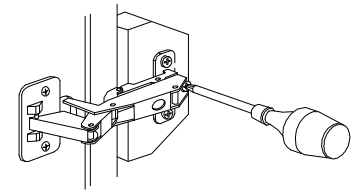
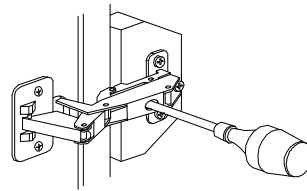
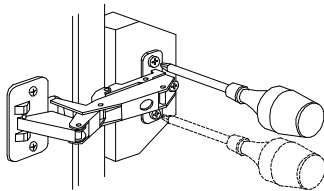
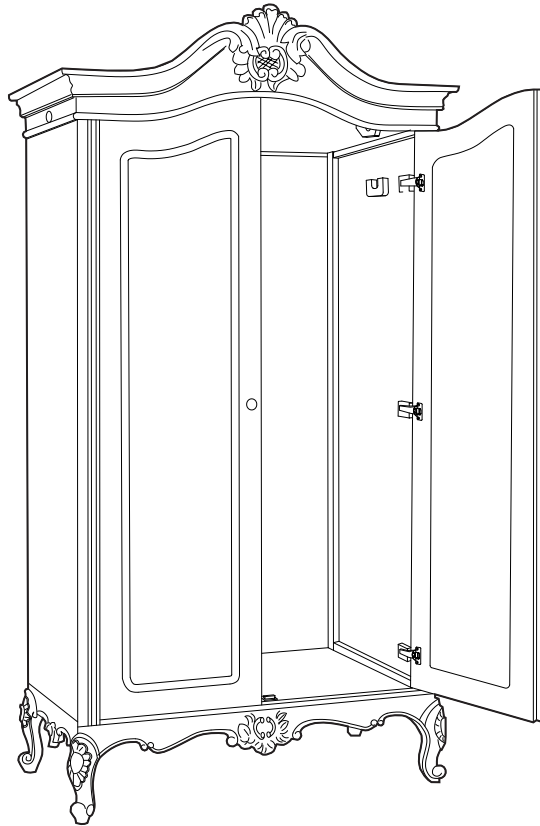

Vertical Adjustable

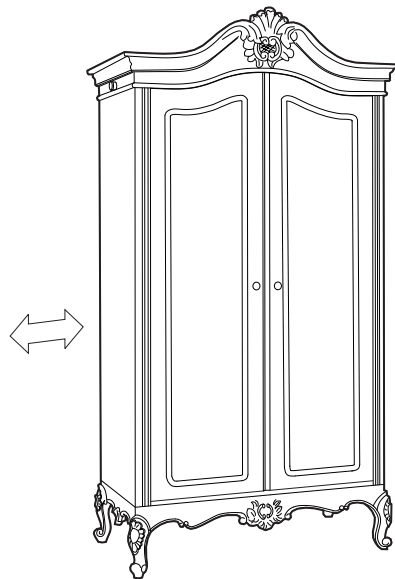

Horizontal Adjustable

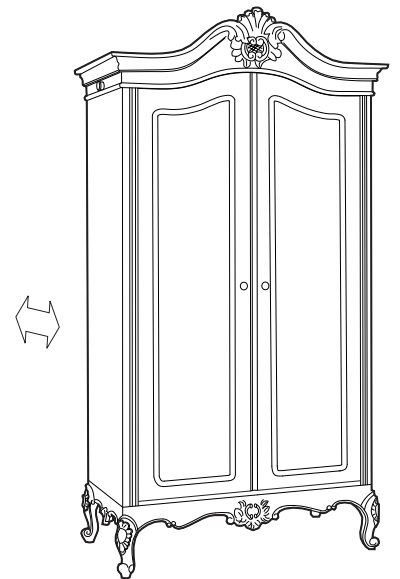

Lateral Adjustable

Gavotte 2 Door Wardrobe KD (GV06) Assembly Instruction

Step 3. - Locate the Hanging Rails (D) into the support



Step 4. - Remove stopper screw from the extending hanging rail (see #1) - Insert extending hanging rail on to the hole of side panel (see #2) - Attach stopper to extending hanging rail using screw (see #3)

